

ELECTROANTENNOGRAPHY

a practical introduction

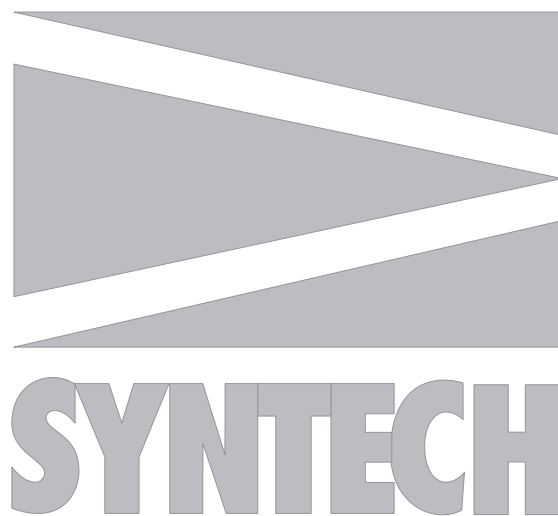

© SYNTECH 2024

Buchenbach, Germany

Reproduction of text and/or drawings is permitted for personal use. The use of reproductions in publications is only allowed if correct reference is made to SYNTECH.

ELECTROANTENNOGRAPHY

a practical introduction

CONTENTS:

INTRODUCTION	1
THE ELECTROANTENNOGRAM (EAG)	2
History	2
The EAG signal	2
PRINCIPLE OF EAG RECORDING	3
The input circuit	3
The quality of the EAG signal	4
RECORDING PRACTICE	5
Preparing micropipettes	5
Adjusting the tip	5
Filling	5
Electrode Preparation	6
Mounting the antenna	6
Alternative methods of antenna preparation	8
Electrically conductive gel	8
STIMULUS PREPARATION	9
Control sources	9
Reference sources	10
BASIC EAG INSTRUMENTATION	10
RECORDING PRACTICE	11
Recording EAG activity profiles	11
Maximum EAG values	11
Dose-Response measurements	11
Normalized EAG responses	11
Averaging EAG responses	11
COUPLED GC-EAD	12
Continuous EAG recording	12
Effluent splitters	13
LITERATURE	

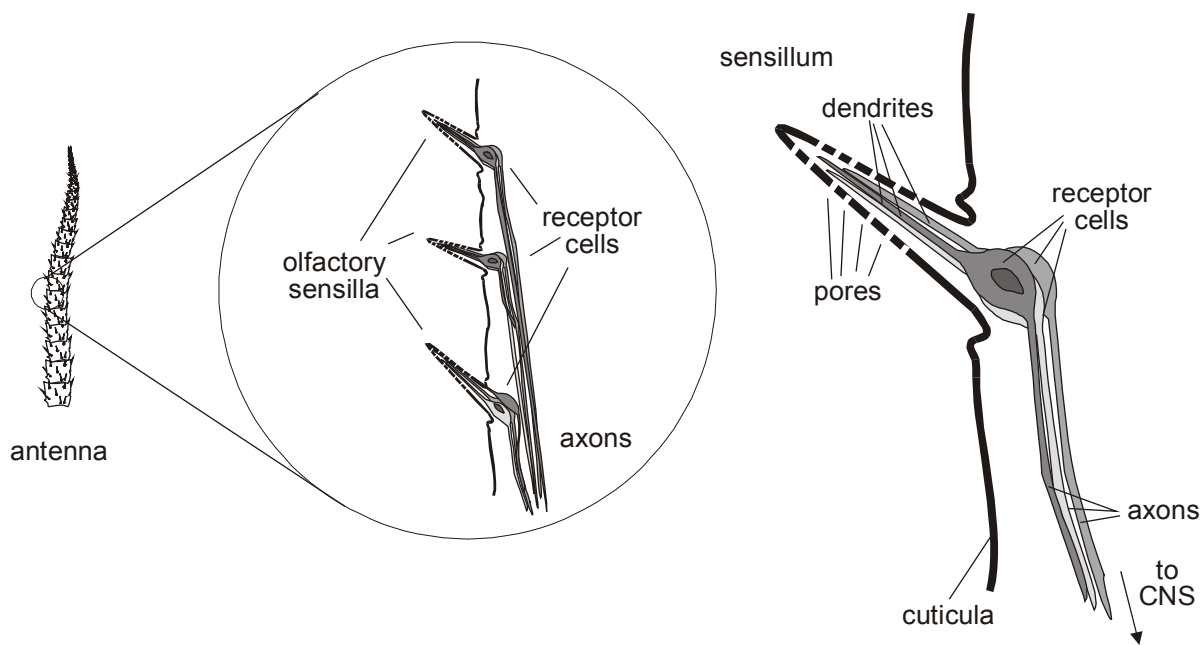

Antennal Structure and Arrangement of Olfactory Sensilla

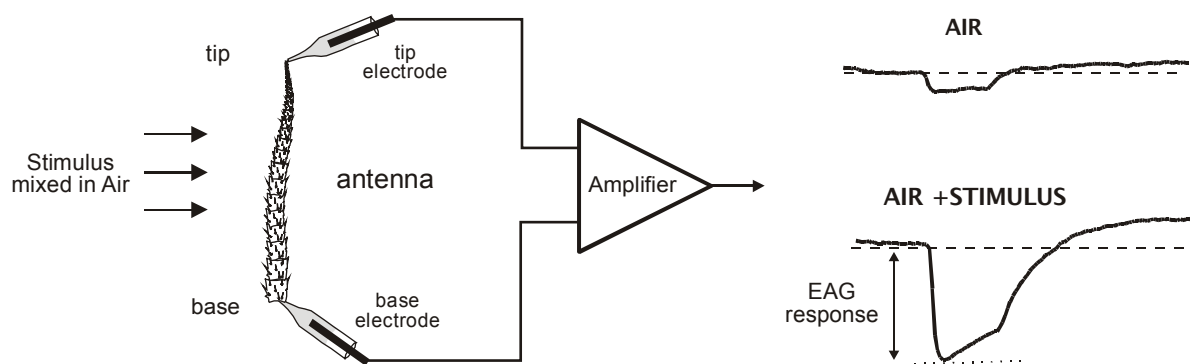

Principle of Electroantennogram (EAG) Recording

INTRODUCTION

Electroantennography (EAG) is a bioassay widely used in experimental entomology for the detection of volatiles perceived by the antennal olfactory apparatus of insects. The method is based on the discovery by Schneider (1957), who recorded small voltage fluctuations between the tip and base of an insect antenna during stimulation with pheromones. Although the precise mechanism behind the EAG signal is not known, it is generally assumed that the measured voltage fluctuation is caused by electrical depolarisations of many olfactory neurons in the insects antenna.

The amplitude of an EAG response increases with increasing stimulus concentrations until a saturation level is reached. The amplitude is further dependent on the nature of the stimulus, the insect species, its sex, and many less well defined factors.

Because a firm theoretical explanation is lacking EAG should be considered an empirical method, which offers practical value, but provides no fundamental data on the physiology of insect olfactory receptors mechanisms. Nevertheless, the practical value is considerable.

The EAG method can be used for many purposes like screening biologically active compounds, purification of extracts, identification of active fractions, selection of active synthetic compounds, concentration measurements in the field, and as a detector in gas chromatography.

EAG recording is technically relatively easy, and does not require highly complicated instrumentation. Nevertheless, the quality of EAG signals is dependent on many factors, which are not always well recognised, and the large variety of insects demands a flexible attitude and a sense for improvisation of the operator.

The aim of this introduction is to describe the basic methods, give practical hints and tips, provide insight in the instrumental requirements, and to guide the experimental scientists –irrespective of their background – in practical EAG recording. For practical reasons the description of the electrical events and electronic signal processing is presented without unnecessary details, which may seem oversimplified for colleagues familiar with electronics.

Although the basic principles are always the same, EAG recording methods may differ in many details. The large variety of insects and the differences in antennal morphology make adaptations in the recording technique necessary and require an inventive attitude.

It is strongly recommended to screen the literature for original papers dealing with a specific insect or research problem. Although not dealing with modern recording technology a basic review of the application of the EAG technique as a bioassay is presented by Roelofs (1984).

 symbol for Voltage Source (V)

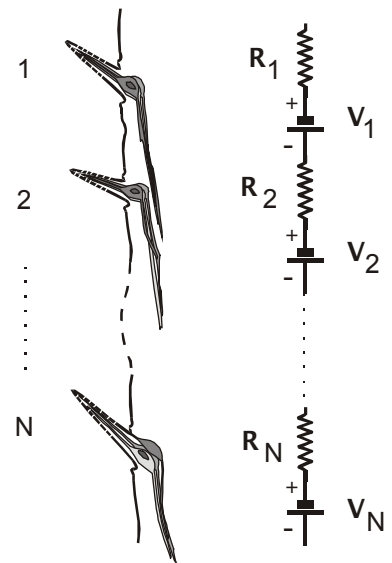
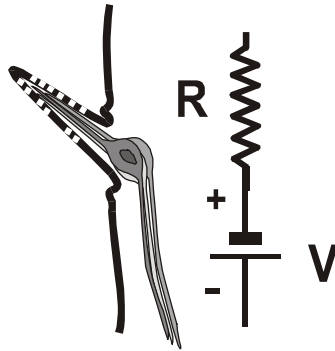

 symbol for Resistor (R)



Electrical symbols for Voltage source (V) and Resistor (R)

Each Receptor cell can be considered to be a combination of a Voltage source (V) and a Resistor (R)

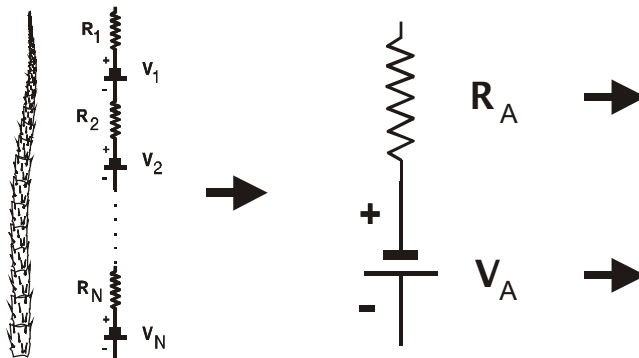
The Olfactory cells in the Antenna form an array of Voltage Sources (V1-Vn) and Resistors (R1-Rn)



The Resistance of a fresh antenna may be in the order of several megOhms (10^8 Ohm) and increases when the antenna dries out

The voltage generated by the antennal voltage source during stimulation (the EAG) may vary from several microvolts to several millivolts

The combination of all N antennal voltage sources (V1-Vn) and Resistors (R1-Rn) can be reduced to a single Antennal Voltage Source (Va) and a single Antennal Resistance (Ra)

THE ELECTROANTENNOGRAM (EAG)

HISTORY

Before the EAG became a practical bioassay several groups in France and Germany experimented between 1953 and 1956 with various insect antennae, different odorants, electrodes, amplifiers (with vacuum tubes) and oscilloscopes trying to measure any electrical response from a stimulated antenna. In their rather primitive arrangements they could register an increase in the amount of noise in response to the presentation of an odour. In the following years slow potentials could be recorded from antennal preparations, and the phenomenon was given the name ElectroAntennoGram or EAG (Schneider, 1957; Schneider et al., 1967), after analogy of the ElectroOlfactoGram (EOG) and ElectroRetinoGram (ERG), all of which are recordings of the responses of many receptor neurons in the organ to the presentation of a stimulus.

THE EAG SIGNAL

The EAG signal is a voltage deflection, which can be measured with suitable equipment, between the tip and the base of an insect antenna when exposed to an adequate stimulus.

Each olfactory receptor cell can be electrically considered to be a combination of a resistor (R) and a voltage source (V). The whole antenna containing a large number of olfactory cells forms an array of voltage sources and resistors, which in practice can be considered as a single antennal voltage source and an antennal resistance.

The antennal voltage source is rather weak and the resistance of the antenna is high, in the order of several megaOhms ($1M \leq 10^6$). This resistance generally increases when the antenna dries out during an experiment.

Generally, the tip of the antenna becomes negative with respect to the base. The amplitude of voltage fluctuation may range from a few microvolts ($1\mu V = 10^{-6} V$) to several millivolts ($1mV = 10^{-3} V$).

For a given species and sex of insect the antennal response may be dependent on many factors:

- 1) the nature of the stimulus
- 2) the strength (concentration) of the stimulus
- 3) the condition of the antenna
- 4) the life time of the preparation
- 5) the number and strength of the previous stimulations
- 6) the quality of the amplifier input

Furthermore, the response is to some degree also dependent on temperature and humidity, even the physiological status of the insect has a certain influence on the response.

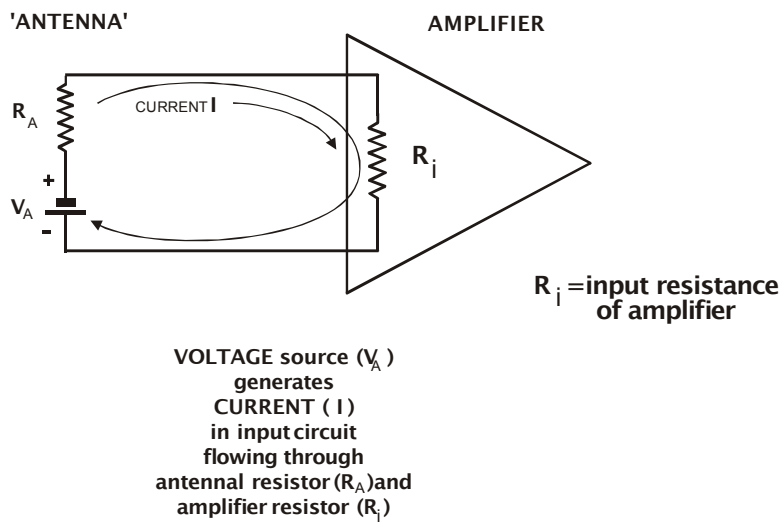
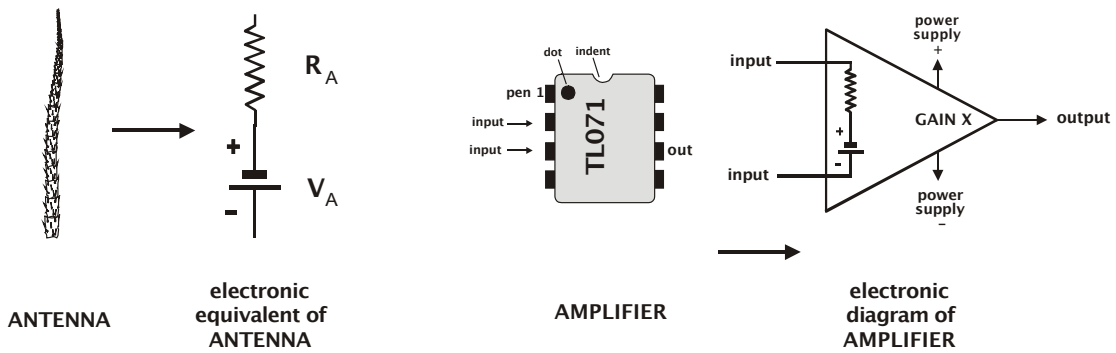

Ohm's Law: $V = I \times R$

Applied to input circuit:

$$V_A = I \times (R_A + R_i)$$

Voltage across Antenna is:

$$I \times R_A$$

Voltage across Amplifier input is:

$$I \times R_i$$

CONCLUSION: R_i (input resistance of Amplifier) should be high compared to R_A (resistance of antennal preparation)

PRINCIPLE of EAG RECORDING

THE INPUT CIRCUIT

Recording the delicate voltage fluctuations across the antenna requires a sensitive instrument, which does not interfere with the physiological processes in the antenna. The small voltage fluctuations need to be carefully picked-up and amplified to a sufficiently high level to drive a recording device, such as an oscilloscope, chart recorder, or computer system.

Modern microelectronics offer a range of high quality amplifiers, available as integrated circuits ("chips"), which are well suited to handle EAG signals. These type of amplifiers are commonly referred to as 'operational amplifiers' or 'OpAmps'.

The most critical part of the recording system is the combination of the antennal preparation and the input of the amplifier. To understand the electrical phenomena in the input circuit, and to know how to optimize the system, the antennal preparation and the amplifier input are considered simplified voltage sources and resistors. Like the antenna is 'reduced' to a voltage source and a resistor, the input of the amplifier can also be reduced to a simple combination of a voltage source and a resistor. However, as the voltage source at the input of a good quality amplifier is constant and very low, it can be neglected in the analysis of the input circuit.

As soon as the antenna is connected to the input terminals of the amplifier and electrical circuit is closed consisting of: 1) the voltage source in the antenna (as a result of receptor cell depolarisations), 2) the resistance of the antenna, and 3) the input resistance of the amplifier. If we apply the famous Ohm's Law (named after George Ohm, 1787-1854) to this circuit it becomes clear that the voltage across the antennal resistance and that across the input resistance of the amplifier is determined by the ratio of these resistances. In other words: the higher the resistance of the amplifier input with respect to the antennal resistance the higher the voltage across the input of the amplifier will be; and that's the EAG response we want to measure.

For example: the voltage source of the antenna generates 1 mV (one millivolt = 10^{-3} V), the antennal resistance is 10 M Ω ($10^7 \Omega$), and the input resistance of the amplifier is 1 M Ω ($10^6 \Omega$), then the current in the input circuit is: $I = V_a / (R_a + R_i) = 10^{-3} / (10^7 + 10^6) = 10^{-10}$ A (= 0.1 nanoAmpere); then the voltage measured across the input of the amplifier is: $10^{-10} \times 10^6 = 10^{-4}$ V = 0.1 mV. In this situation the voltage picked-up by the amplifier is about one tenth (!) of the voltage generated by the antenna, because the input resistance of the amplifier is ten times lower than the antennal resistance. In the opposite situation, if the amplifier input resistance is 10 times higher (100 M Ω)

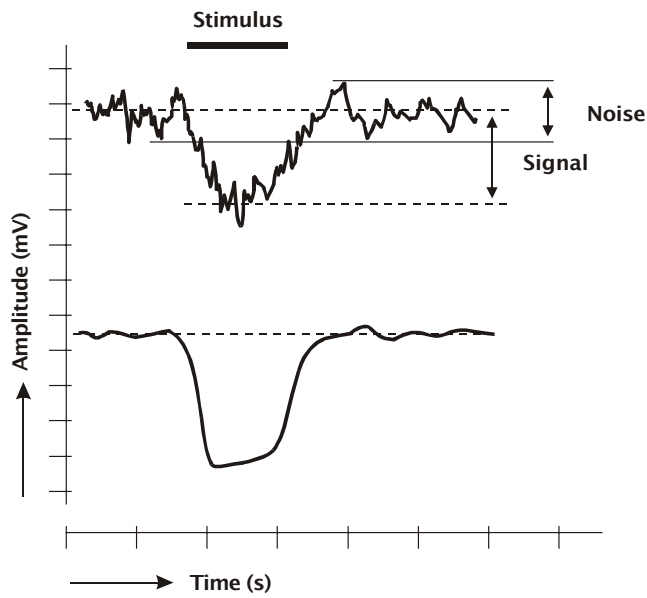

Bad Signal/Noise Ratio

Good Signal/Noise Ratio

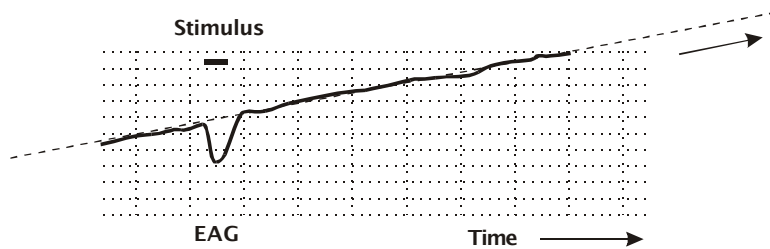

Upward Base Line Drift

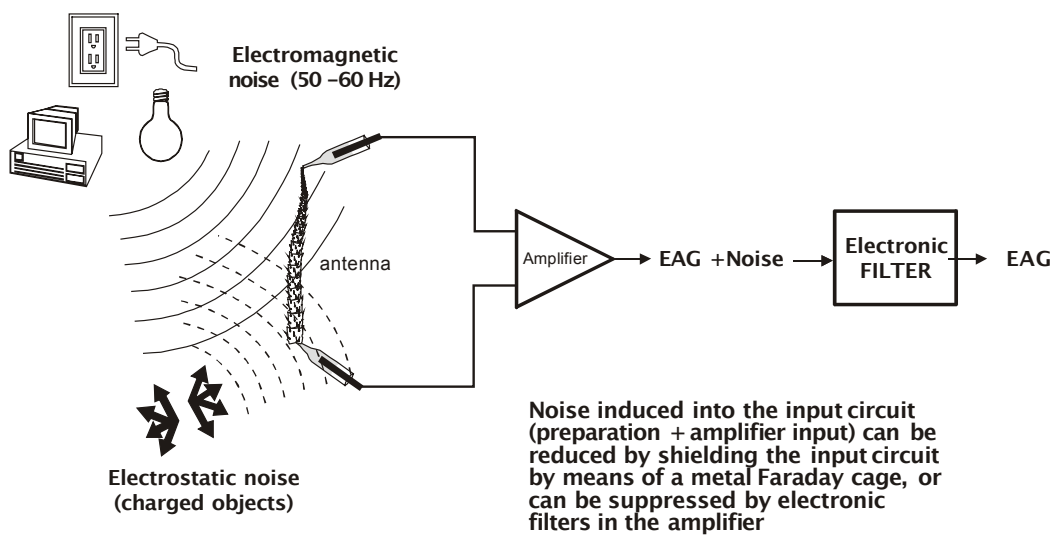

than that of the antenna ($10\text{ M}\Omega$) almost the full voltage of 1 mV is present at the input of the amplifier, and thus available for further amplification.

The conclusion from this exercise with Ohm's law is that the input resistance of the amplifier should be much higher than that of the antennal resistance in order to measure the voltage generated in the antenna sufficiently accurate. Modern OpAmps have an input resistance of $10^{12}\ \Omega$ or more.

THE QUALITY of THE EAG SIGNAL

Absolute values of EAG signals range between a few microvolts ($\mu\text{V} = 10^{-6}\text{ V}$) and several millivolts ($\text{mV} = 10^{-3}\text{ V}$). However, what is more important is the ratio between the absolute EAG signal and the – unavoidable – background noise: the so called Signal to Noise Ratio (S/N Ratio). If the noise level is larger than the EAG signal there is not much to measure, even if the EAG signal is several mV. On the other hand a low EAG signal of only a few microvolts can very well be measured if the noise is only a fraction of a microvolt.

Therefore, the noise in the system should be maintained at the lowest possible level, without suppressing the true EAG signal.

There are many sources of noise in an EAG recording system:

- 1) noise generated in the resistances of the antenna and the input of the amplifier.
- 2) 'biological' noise generated in the antenna
- 3) noise from external sources interfering with the input circuit.
- 4) a slow up or down moving of the signal level over time: drift.

The first source of noise is typical for the antenna and for the quality of the amplifier; modern amplifiers do not produce any noise significant for EAG recording and can be neglected. The noise due to the resistance of the antenna can only be suppressed by using fresh antennal preparations from good quality insect batches.

'Biological' noise may be induced by muscle activity in or close to antennal structures and is rather irregular; this type of noise can be minimized by proper handling of the preparation and by using the most suitable method of preparation for a particular type of antenna.

Noise from external sources can be managed to a great extent by adequate design of the recording set up. The strongest external noise is induced by electromagnetic radiation from the mains power supply system (110 V 60 Hz, or 220 V 50 Hz) in or nearby the experimental arrangement. The input circuit of the EAG set up is very susceptible to this type of radiation due to the high input resistance of the amplifier input and the antennal preparation. There are two methods to reduce this noise:

- 1) by enclosing the recording site by under an electromagnetic shield: a so called Faraday cage (named after Michael Faraday, 1791–1867);

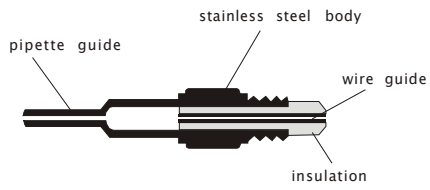

CROSS SECTION of ELECTRODE HOLDER

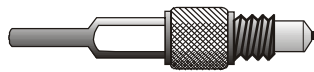

SILVER WIRE 0.3 - 0.5 mm

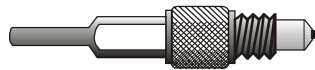

make tiny bend at end of wire



insert wire into holder

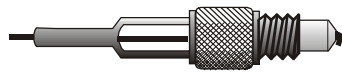

screw holder onto probe

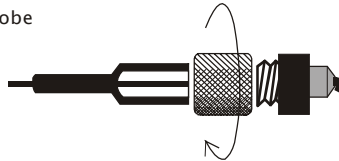

GLASS PIPETTE ELECTRODE diam. 1.5 mm

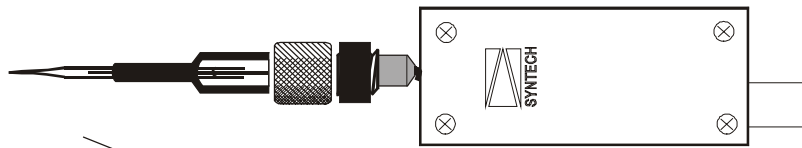

insert pipette into electrode holder

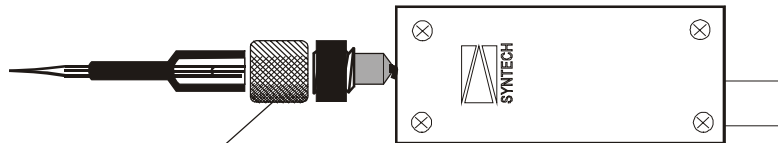

Do NOT connect electrode holder to ground!

ELECTRODE PREPARATION

2) using an electronic filter, which blocks the noise picked-up by the amplifier, but passes the EAG signal.

The last type of noise, drift, is a quite inconvenient phenomenon in EAG recording. Due to drift the signal gradually runs out of scale from the recording or display device and has to be reset by the operator from time to time. Drift is particularly a problem during long time recordings as in coupled gas Chromatography– ElectroAntennographic Detection (GC–EAD). Fortunately, it is relatively easy to cancel this drift by proper electronic filtering resulting in ‘automatic base line control’, a feature present in most SYNTECH EAG amplifiers and recording systems.

Other sources of external noise are induced by air currents around the preparation (received by mechanoreceptors on the antenna), static electric charge from synthetic fabric, movements of the operator, light fluctuations, and sudden changes in humidity (induced by air conditioners). Care should be taken to avoid all these kinds of interference.

RECORDING PRACTICE

PREPARING MICROPIPETTES

For EAG recording contact with the base and the tip of the antenna is generally made by means of glass micropipette electrodes. The use of metal electrodes combined with standard saline solutions is not recommended, because the noise introduced by the electro–chemical potentials developed in these electrodes. Suitable capillary glass tubes (1 – 2.5 mm outer diameter) are drawn to a fine point using a microelectrode puller, or manually in a flame.

Adjusting the tip

The tips of machine–pulled glass micropipettes are too fine for EAG purposes. Therefore, carefully break off the tips with the help of fine forceps to an inner diameter wide enough to enable insertion of an excised antenna. It is helpful to observe both the antenna and the pipette tip under the stereo microscope while adjusting the tip.

Filling

Micropipettes are filled with an electrically conductive solution. A solution of 0.1 N KCl is frequently used; however more complicated ‘Ringer’ solutions for insects can be used.

To prevent evaporation of water at the tip of the pipettes causing KCl crystal formation, which may result in bad EAG signals, a small amount (approximately 1–5% by volume) of POLYVINYLPIRROLIDONE (PVP) can

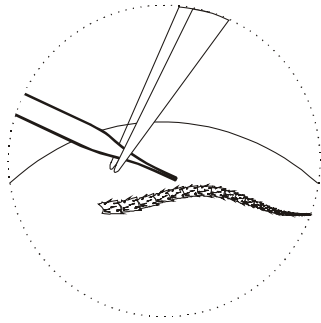

Break off the tip of the micropipette

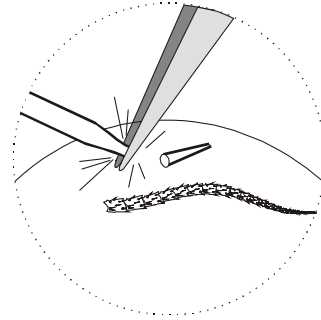

Make the tip diameter slightly larger than the diameter of the antennal base

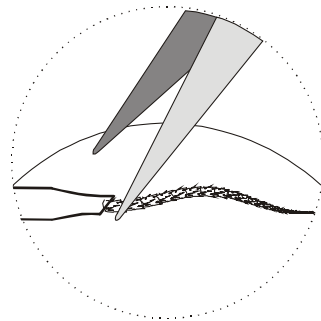

Carefully slide the antennal base inside the pipette tip. Do NOT take the antenna BETWEEN the forceps!

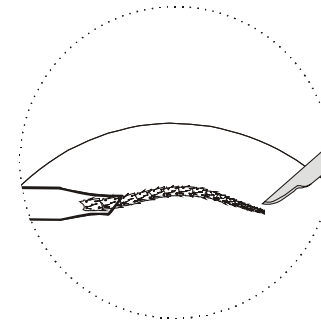

Cut off a few segments from the tip

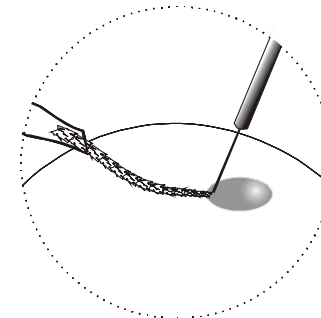

Moisten the tip in a droplet of saline

Steps in preparing the micropipette tip, fixing the base of the antenna, and cutting and moistening the tip

be added to the KCl solution; shake well and let it stand for a while until the solution becomes clear. PVP is a very large molecule (Mol. Wt. 360.000) forming a film on the surface of the fluid in which it has been dissolved, thus preventing evaporation.

Pipettes for EAG work have a relative wide tip; they fill spontaneously when dipped in the saline due to capillary action. Only fill the first 10 – 15 mm from the tip.

Fill the micropipettes only shortly before making the antennal preparation.

ELECTRODE PREPARATION

The use of SYNTECH stainless steel electrode holders and the insertion of electrode wire and glass pipette is illustrated in the figure at the left.

The body of the different ('recording') electrode, which is mounted onto the PROBE, is not on ground potential. It is connected to the output of the first (unity gain) operational amplifier inside the PROBE, thus forming a so called 'guard'. Such a guard circuit constitutes an effective shield against noise interference and eliminates the effect of leakage currents across the input.

Practice has thought that in most applications AgCl coating is not required, because the input 'window' of the PROBE allows offset voltages up to 400 mV.

MOUNTING THE ANTENNA

A variety of methods to fix the antenna between the tips of the micropipettes have been described. For filiform (elongated, wire-shaped) antenna the most practical method is to insert the ends of the antenna into the tips of the micropipettes.

The procedure is as follows:

- 1) Excise the antenna from the head of the insect using a micro-scissors or fine dissecting knife.
- 2) Place the antenna in the field of view of a medium power stereo microscope
- 3) Bring the tip of the micropipette close to the antenna under the microscope.
- 4) Break off the tip of the micropipette using a micro forceps.
- 5) While breaking the tip compare the size of the tip opening with the diameter of the base of the antenna and try to make the inner diameter of the micropipette to be slightly larger than the outer diameter of the antennal base.

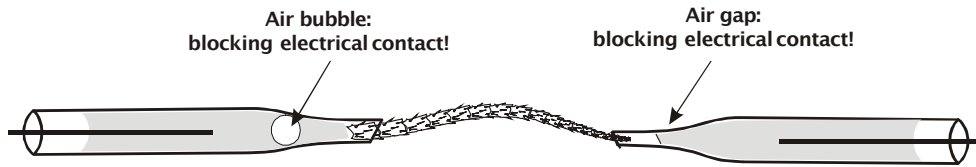

Excised antenna between micropipettes

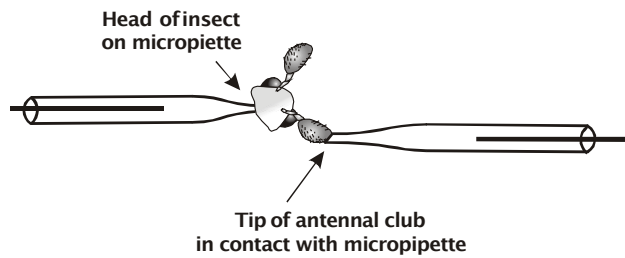

Example of mounting a club-shaped antenna

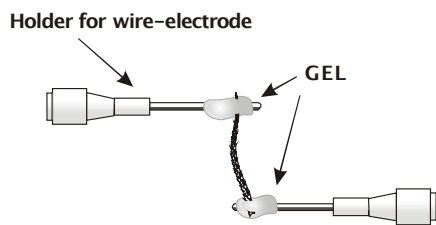

Antenna contacted using droplets of electrically conductive gel

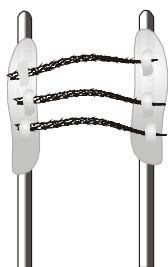

Multiple antennae mounted between two metal electrodes using conductive gel

Example of whole-insect preparation

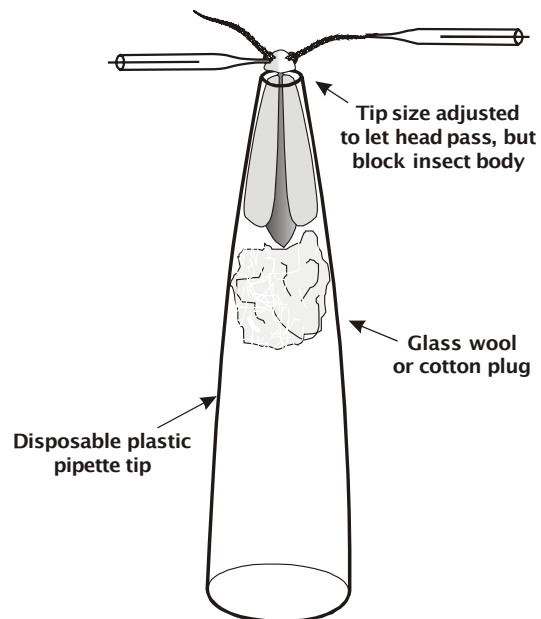

- 6) Carefully slide the base of the antenna inside the tip of the micro pipette
do not take the antenna between the tips of the forceps: this will certainly damage the antenna.
- 7) Clip off a few segment from the tip of the antenna
- 8) Put a droplet of saline (with PVP) in the field of view.
- 9) Moisten the tip of the antenna by forcing it into the saline droplet using a fine dissecting needle.
Moistening the tip of the antenna greatly facilitates contact making with the recording electrode.
10. Insert the pipette holding the antenna into the electrode holder.
11. Prepare the micropipette for the tip contact. The size of this tip should be large enough to allow insertion of the cut tip of the antenna. Insertion the antenna tip is facilitated if the pipette tip is broken at an angle.
12. Move the manipulators holding the micropipette electrodes towards each other and position the tip of the antenna close to the tip of the open micropipette.
13. Slip the tip of the antenna into the open tip of the recording micro pipette.
A little help with a fine dissection needle or preparation hair may be required to guide the tip of the antenna.
14. inspect the micropipettes for absence of any air bubbles, which might have been developed during insertion of the antenna.
Even a single tiny air bubble will block the electrical circuit and prevent proper EAG recording.
15. Watch the recording device: a relative stable base line should be visible if the antenna makes good contact with the electrodes.

Depending on the morphology of the antenna this procedure may need to be adapted

Very short club-shaped antenna, as found in flies and beetles, can hardly be excised from the head without causing serious damage to the antenna; In such cases the antenna is left on the head, but the head is excised and mounted on the micropipette tip; The club of the antenna is placed against the end of the recording micropipette without cutting off any segments from the antenna tip.

It is not always necessary or feasible to cut off the tip segments; good EAG recordings can be made by just contacting the open end of the recording micropipette to the end segment of the antenna. In such situations the size of the tip of the recording micropipette could be as large as the diameter of the end segment of the antenna.

Before replacing a used antenna by a fresh one the micro pipettes need to be cleaned or replaced. If PVP is added to the saline it is recommended to use fresh pipettes for each new antennal preparation.

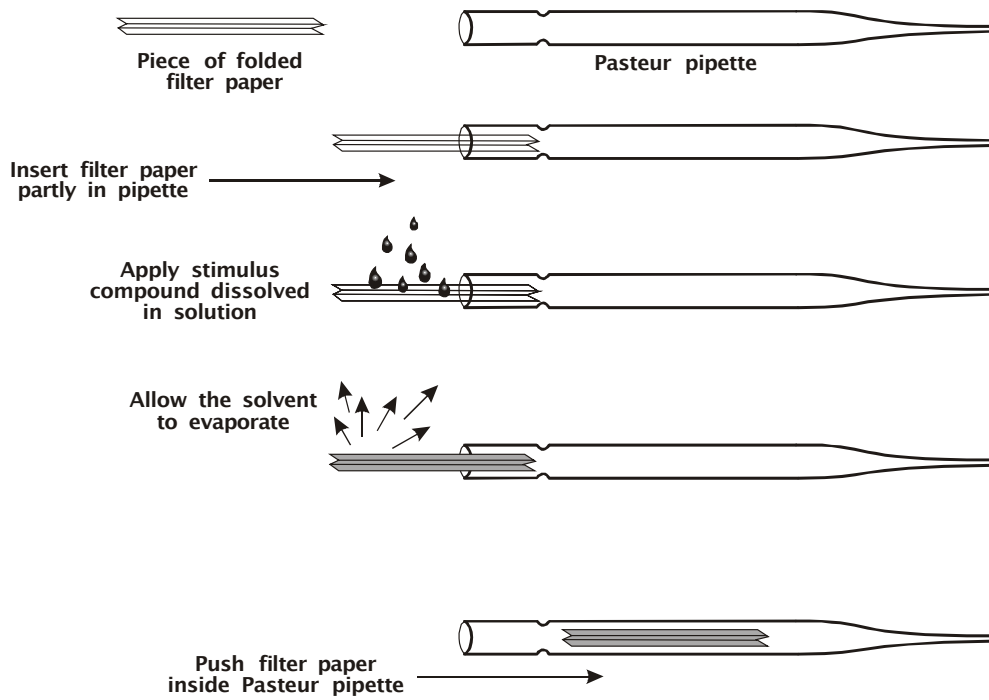

Stimulus source preparation using Pasteur pipettes

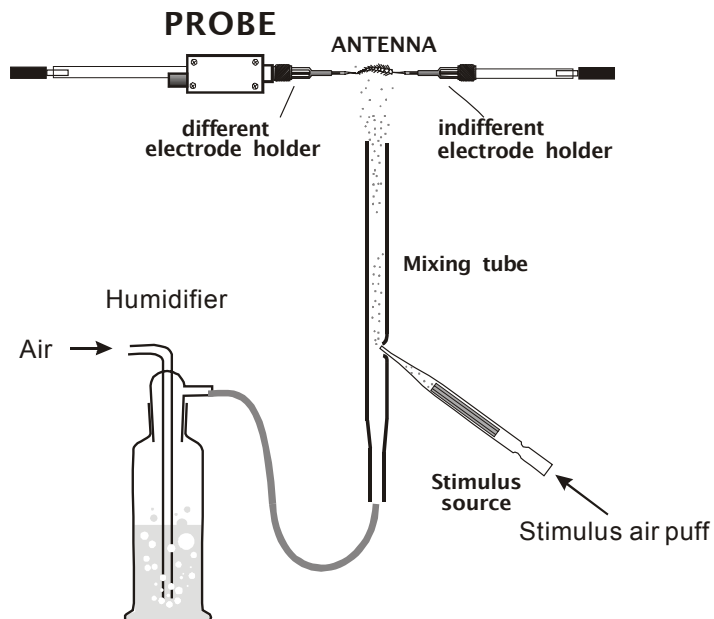

Basic Stimulation and Recording arrangement

ALTERNATIVE METHODS OF ANTENNA PREPARATION

Whole Insect preparations

The life time of an excised antenna is limited – depending on many factors – from only few minutes up to one or two hours. If only a few insects are available, or if long duration recordings need to be made like in coupled gas chromatography–electroantennographic detection (GC–EAD) it might be advantageous to leave the antenna attached to the insect.

A standard method for making intact insect preparations does not exist. The insect needs to be immobilized before the recording micropipettes are brought into contact with respectively the base and the tip of the antenna. The insect can be mounted onto a small platform and fixed by means of plasticine and tiny copper wires. Another method is to fix the insect inside the tip of a disposable plastic pipette, the diameter of the tip of which has been adjusted to allow the head to protrude outside the tip while the body of the insect is caught inside the pipette body.

In all whole insect preparations one micropipettes is in contact with the (cut off) tip of the antenna, whereas the other pipette is inserted close to the base of the antenna. It is important to place the basal pipette close to the antennal base to avoid interference with electrically active structures, like antennal muscles.

Electrically conductive gel

A very attractive method of mounting an excised antenna is the use of an electrically conductive gel. The gel can be used in micropipettes to replace the KCL saline solution, or can be used applied onto a metal electrode surface into which the antennal ends are inserted. Unlike a water based saline (KCL) solution, which repels the hydrophobic antenna, the gel easily forms a contact with the antenna. The end of the antenna can be simply pushed into droplets of the gel, which are applied to the metal electrodes (silver or stainless steel).

Practice has shown that a proper quality of gel (Spectra 360, Parker, Orange, N.J. USA) does not significantly interfere with the EAG responses, and that it can be used to great advantage for a large variety of preparations. A good quality gel does not dry out quickly, and preparations may last for more than an hour.

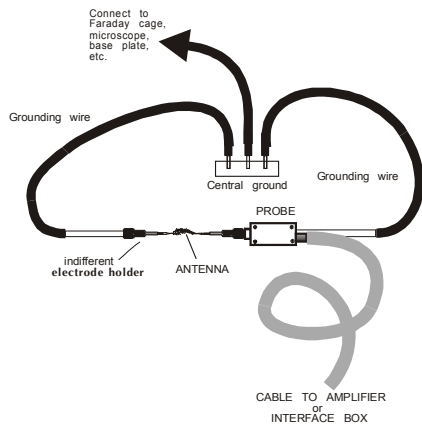

Basic Input Circuit

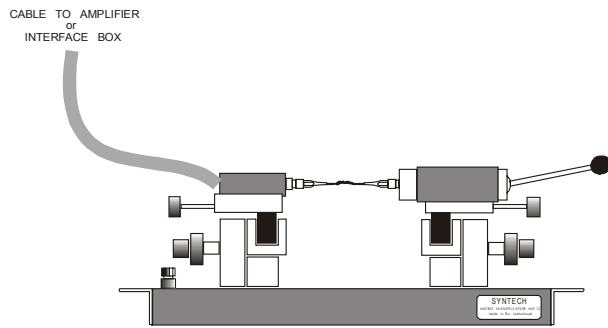

Syntech micromanipulator assembly

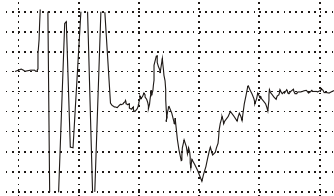

no contact bad contact

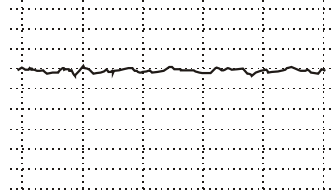

normal base line

A properly connected antenna produces a slightly fluctuating base line

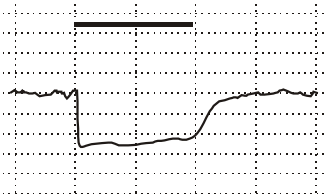

Long stimulation

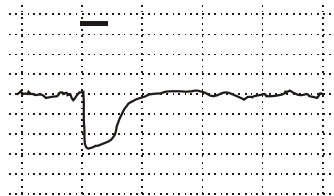

Short stimulus puff

A short stimulus evokes practically the same EAG deflection

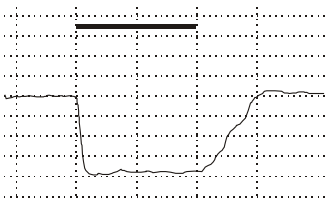

Manual base line control

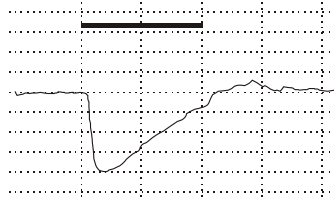

Automatic base line control with T.C.= 1s

Effect of the automatic base line control on the shape of the EAG. The effect is less for longer Time Constants (>3s)

STIMULUS PREPARATION

STIMULUS SOURCES

Standard Pasteur pipettes containing a strip of filter paper, onto which the test compound has been applied, make very practical stimulus sources.

The are prepared as follows:

- 1) A zig-zagfolded piece of filter paper (size about 1 x 5 cm) is partly inserted in the wide opening of the Pasteur pipette.
- 2) A specified amount (10 – 100 microliter) of a suitable solvent (hexane) containing a certain concentration of the test compound is applied onto the filter paper using a micropipette.
- 3) The solvent is allowed several minutes to evaporate.
Non-volatile solvents do not require this step; However, the solvent should be well and evenly absorbed by the filter paper.
- 4) The filter paper is pushed completely inside the Pasteur pipette
- 5) The wall of the Pasteur pipette is marked with a code for the stimulus contents and amount.

Stimulus sources are generally prepared containing amounts of test compound in decadic steps. The amounts are expressed in picogram (1 pg = 10^{-12} g, nanogram (1 ng = 10^{-9} g), or microgram (1 μ g = 10^{-6} g).

In order to achieve these exact amounts on the filter paper the concentration of the solutions are prepared in such a way that the volume (10 or 100 μ l) of solvent applied onto the filter paper contains this amount.

Example: For a stimulus source containing 1 μ g of test compound the applied volume of 100 μ g solvent must contain 1 μ g of test compound, and the 100 μ g solvent volume is pipetted from a stock solution with a concentration of 10 μ g per ml. Stock solutions of concentration steps can be stored in the refrigerator.

Pheromone compounds are generally dissolved in hexane. Many plant volatiles are applied dissolved in paraffin oil.

Care has to be exercised not to contaminate the outer wall and the open end of the Pasteur pipette with solvent and/or test compound.

CONTROL SOURCES

Three types of control pipettes are used:

- 1) Clean Pasteur pipettes. Purpose: checking contamination of the pipettes
- 2) Pipettes with filter paper only: Purpose: test for filter paper contamination.
- 3) Pipettes with filter paper and solvent to test contamination of solvent.

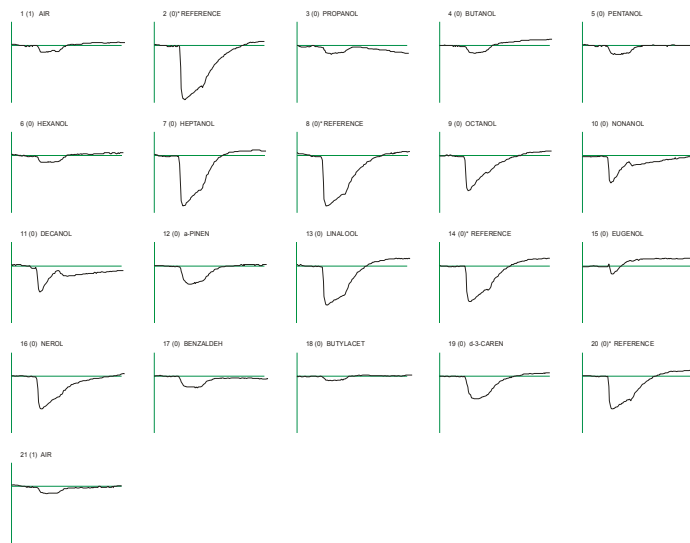

EAG recording session of 21 stimulations

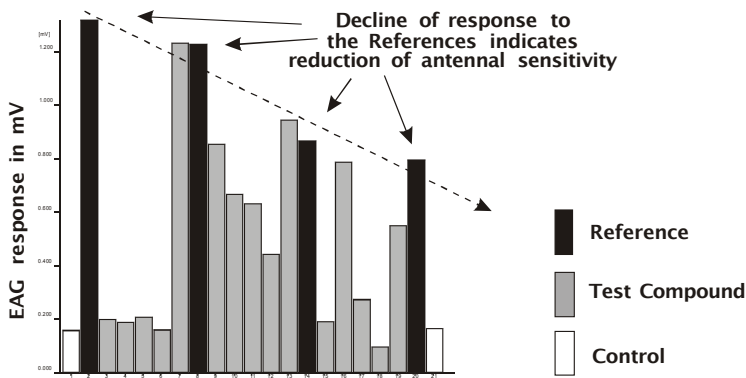

Graph showing maximum EAG responses in absolute mV values

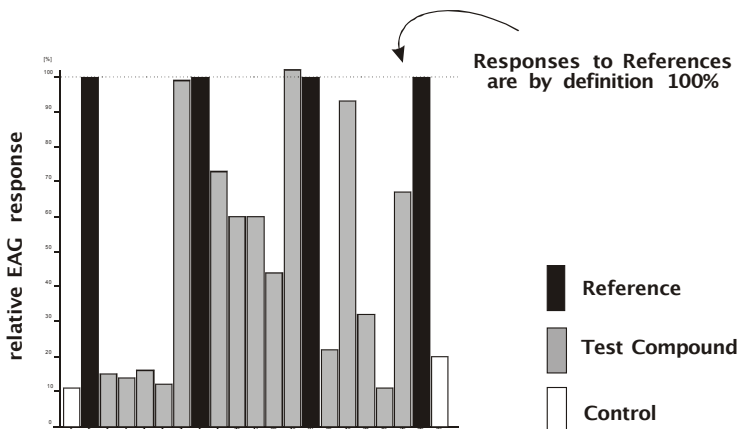

Graph showing normalized EAG responses in % relative to reference

REFERENCE SOURCES

In the course of making EAG recordings the sensitivity of the antenna gradually declines. To monitor this decline a reference stimulus is applied at regular intervals during a recording session.

The reference compound can be any compound evoking a reasonable EAG signal.

The responses to the references are also used to normalize the data obtained in single or multiple recording sessions.

BASIC EAG INSTRUMENTATION

The basic elements of an EAG set up are:

- 1) Antennal preparation and recording electrodes with manipulators
- 2) Amplifier and signal processing electronics
- 3) Signal display and recording system
- 4) Stimulus application system

ad 1): In a conventional EAG system the antenna is mounted between two glass pipette electrodes. Recently, devices are developed using electrically conductive gel, in which the glass pipette electrodes are replaced by stainless steel wire electrodes directly integrated with the first amplifier stage.

ad 2): Many types of EAG amplifiers exist. They all offer a high input resistance stage and gains from 10 – 1000 x. Most amplifiers have a provision for base line adjustment ('offset' adjust); Syntech EAG amplifiers and computer interfaces have built-in filters to suppress noise and automatic or manual base line control.

ad 3): Classical EAG recording makes use of an oscilloscope to display, and a chart recorder to record the EAG responses. The amplitudes are measured manually from the recording paper strip. Modern EAG systems use a computer for display, recording and analysis functions.

ad 4): During EAG recording the antenna needs to be flushed with a constant flow of filtered and humidified air. The flow is usually adjusted between 25 and 50 cm/s. The test stimuli are mixed into this constant air flow via a small aperture into the tube directed to the antenna. The duration of the test puff is generally between 0.3 and 0.5 s, which is sufficient to stimulate the antenna to its maximum voltage deflection; longer stimulation does not result in a larger signal, but may cause early adaptation and loss of sensitivity during a measuring session. Only in case one wants to

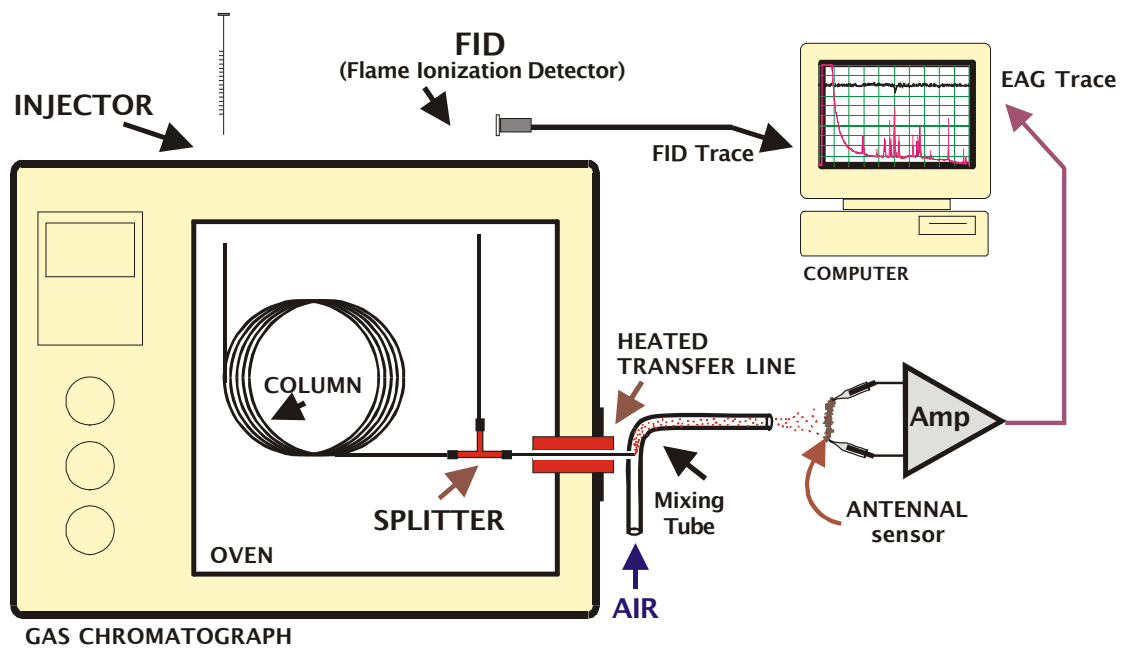

Coupled gas chromatography –electroantennographic detection (GC-EAD)

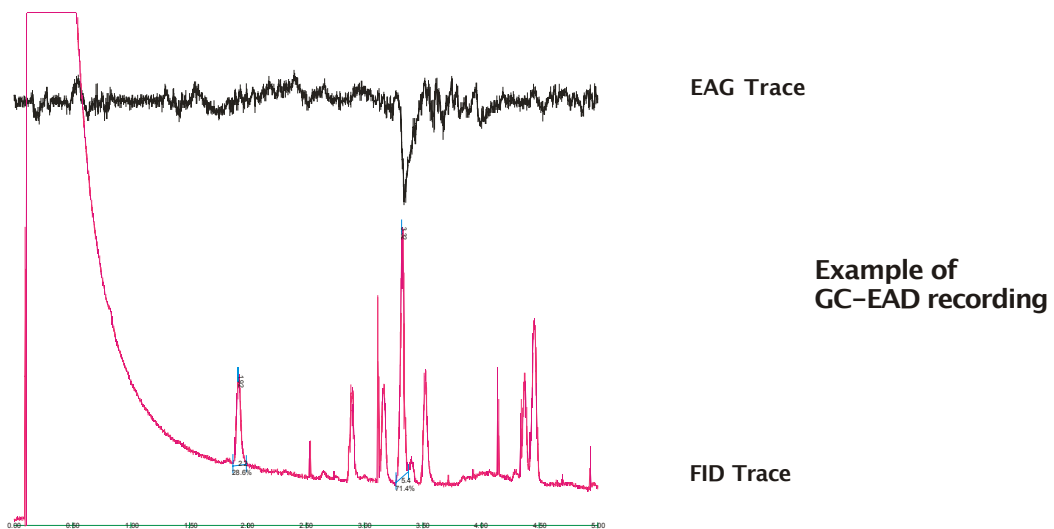

measure the shape of the EAG signal in response to a stimulus it is necessary to present stimuli from 1 – 2 s.

RECORDING PRACTICE

Recording EAG activity profiles

The activity of individual test samples, compounds or extracts, are compared in a measuring session, during which all compounds are sequentially applied to the one or more antennal preparations.

At the beginning of a measuring session control stimulus sources are presented (clean air, pipette with only filter paper and/or solvent). At regular intervals, or alternating with the test compounds, reference stimuli are applied.

To allow the antenna to recover after a stimulation and to avoid adaptation of the sensory cells stimuli are presented at intervals of at least 30 s. Strong stimuli require a longer interval.

Maximum EAG values

The maximum (negative) amplitudes of the individual EAG responses are measured and presented in a graph. From the decline of the amplitudes to the reference stimuli it is immediately clear how the sensitivity of the antenna decreased in time.

Dose-Response measurements

In order to establish the activity range of a certain compound it is applied at increasing concentrations expressed as amounts present in the stimulus source. Generally the concentrations are prepared in decadic steps. From the dose-response curve information about the sensitivity threshold and saturation level of the antenna for a particular compound can be obtained.

Normalized EAG responses

To compensate for the decline in antennal sensitivity during a recording session, the values of the maximum EAG responses are expressed relative to the responses to the references. In this normalization procedure the responses to the references are defined to be 100%. The values between two adjacent references are corrected for the decline in the values to the references by linear interpolation. The Syntech EAG software calculates the normalized values automatically.

Averaging EAG responses

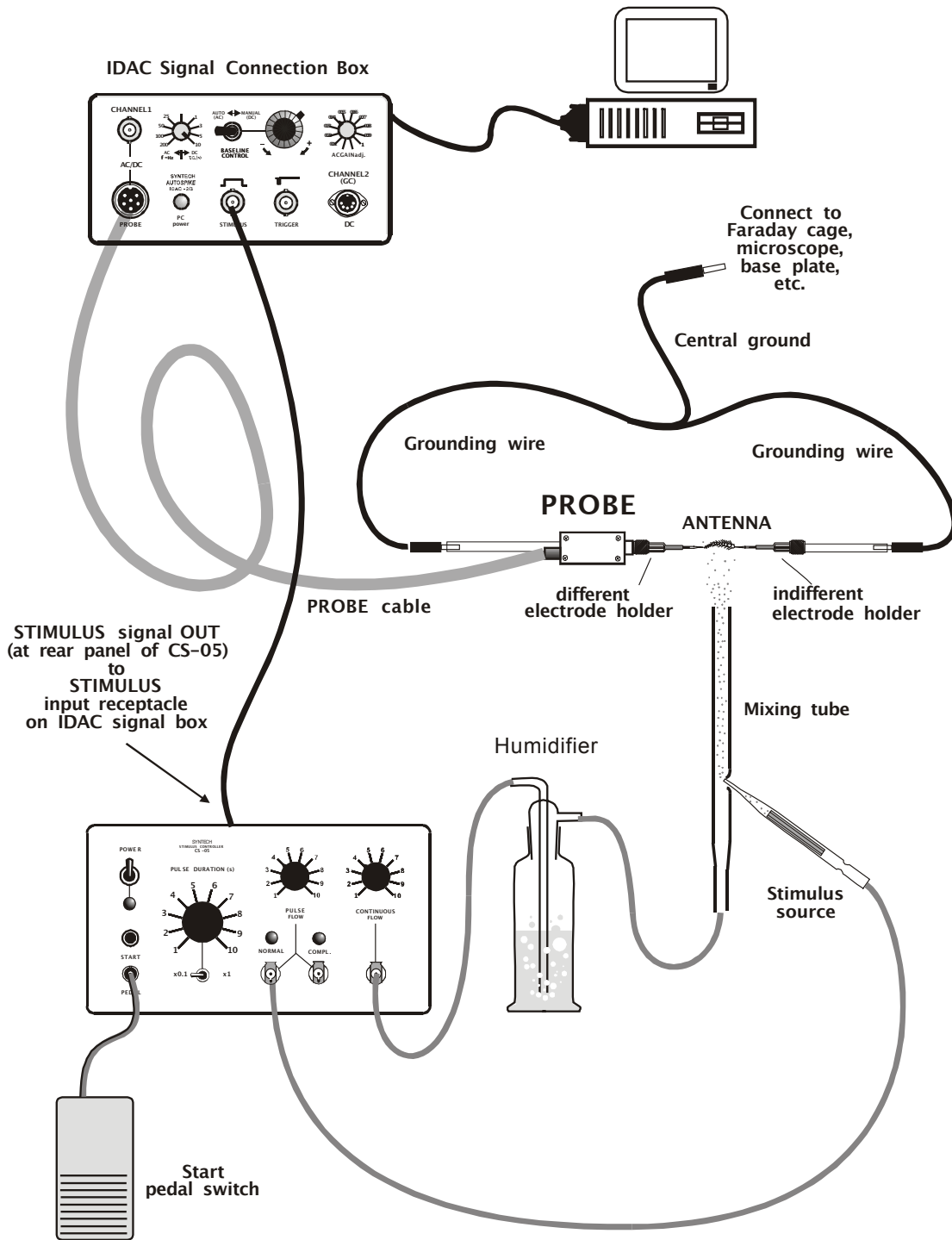

Connections for EAG recording

EAG recording sessions can be repeated several times to allow averaging of the results. As an alternative stimuli can be presented several times during a single session, if the life time of the antenna permits. In any case the measured EAG responses need to be normalized using a reference for two reasons: 1) because of the decline in antennal sensitivity during a measuring session, and 2) because of the large differences in overall sensitivity between individual antennae.

COUPLED GAS CHROMATOGRAPHY - ELECTROANTENNOGRAPHIC DETECTION (GC-EAD)

Modern high resolution capillary gas chromatography (GC) is a powerful technique for the separation of small amounts of individual components in complex mixtures. However, the physico-chemical detectors used to monitor the eluting fractions are not selective to specific components of biological activity. However, a highly selective and sensitive detection apparatus is present on the antenna of many insects, and this detector system is used in the EAG bioassay.

Combining the separation power of the GC with the EAG technique fully utilizes the analytical capabilities of these two techniques.

In order to use the insect antenna as a GC detector the effluent from the column has to be directed to the antennal preparation. In practice this is realized by splitting the column effluent into two branches: one leading to the standard detector (usually an FID), the other one leading to the antennal preparation outside the GC oven via a suitable transfer line. To prevent condensation of fractions in the transfer line, this needs to be heated up to the maximum temperature of the applied GC program.

After leaving the heated transfer line the effluent is mixed in a constant flow of filtered and humidified air, which is directed to the antenna as in a standard EAG arrangement.

During the GC run the antenna is continuously exposed to the eluting fractions; However, it will only show a response to fractions containing compounds, which activate the receptor cells on the antenna. The signal from the antenna is monitored and recorded simultaneously with the signal from the FID, and both signals are synchronized in time.

Continuous EAG recording

During continuous EAD recording is GC-EAD measurement the antenna is exposed to stimuli eluting as 'peaks' in the chromatogram, and the signal from the antenna is recorded continuously. Without automatic base line control the signal from the antennae would run out of the display window after some time; Therefore, the automatic base line control is very useful in GC-EAD recording. However, the baseline correction should not be to

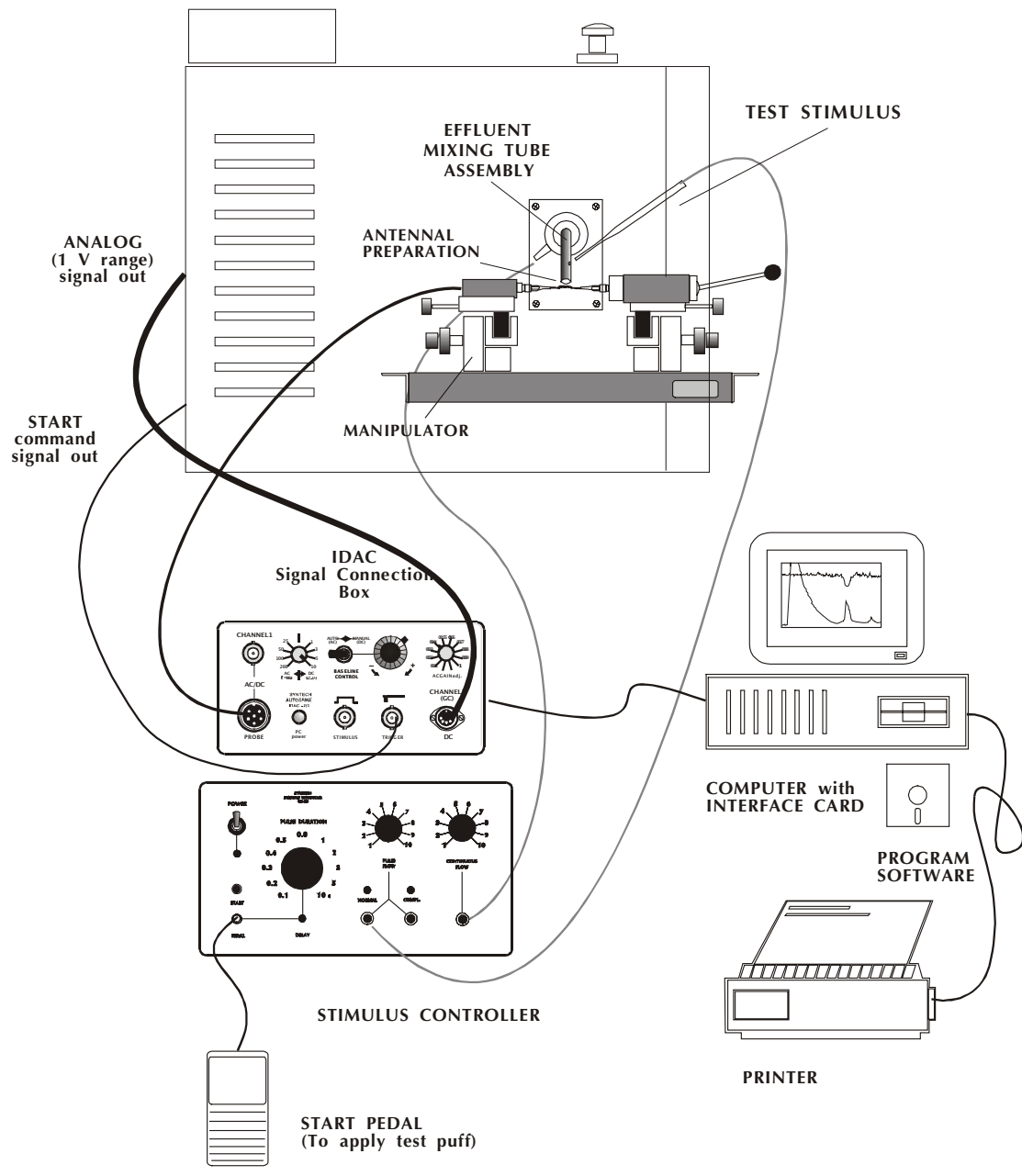

Typical Syntech GC-EAD recording arrangement

strong: there should be enough time to follow the elution of active 'peaks'. The effectiveness of the automatic baseline control can be adjusted by changing the Time Constant (T.C.) of the control system.

The higher the value of the selected Time Constant (T.C.), the more time is needed to return to zero after a certain deflection of the signal. The Time Constant is the time required to reduce the original deflection of a signal by 63% of this deflection.

For EAG signals evoked during application of a short puff, a good value would be a time constant of 1 – 3 seconds.

However, for recording of GC-EAD signals from the effluent of a gas chromatograph (GC-EAD recording), a Time Constant of 5 – 10 seconds is usually an appropriate setting (The faster the Rise Time of the peaks, the lower the Time Constant can be).

Effluent Splitters

A good quality effluent splitter is crucial for successful GC-EAD recording. For many purposes 'Quick seal' all glass universal Y-splitters, which are suitable for a wide range of column diameters, perform well. However, these splitters can not be removed from the column after installation and conditioning.

If columns need to be exchanged regularly a detachable splitter is advisable. Cheap metal splitters have a large internal dead volume causing peak broadening and tailing. To cancel the effect of dead volume, the effluent can be mixed with a additional make-up carrier gas to increase the flow and thus reducing the dead volume effect. Adding a make-up gas flow has the additional advantage that flow differences between the FID and EAD line are minimized.

LITERATURE

- Roelofs, W.L. (1984). Electroantennogram Assay: Rapid and Convenient Screening Procedures for Pheromones. In: Techniques in Pheromone Research (Eds. H.E. Hummel and T.A. Miller), Springer Verlag. pp.-131-160.
- Schneider, D. (1957). Elektrophysiologische Untersuchungen von Chemo- und Mechanorezeptoren der Antenne des Seidenspinners *Bombyx mori* L. Z. Vergl. Physiol. 40. 8-41
- Schneider, D., Block, B., Boeckh, J. and Priesner, E. (1967). Die Reaktion der männlichen Seidenspinner auf Bombykol und seine Isomeren: Elektroantennogramm und Verhalten. Z. Vergl. Physiol. 54, 192-209.
- Struble, D.L. and H. Arn. (1984). Combined Gas Chromatography and Electroantennogram Recording of Insect Olfactory Responses. In: Techniques in Pheromone Research (Eds. H.E. Hummel and T.A. Miller), Springer Verlag. pp.-161-178.